

Article number: 2314449461

Description: E+G polyamide wheel  
RE.F8-125-SSL-WH - Turning plate wo/brake in Zinc-plated steel

## Measures

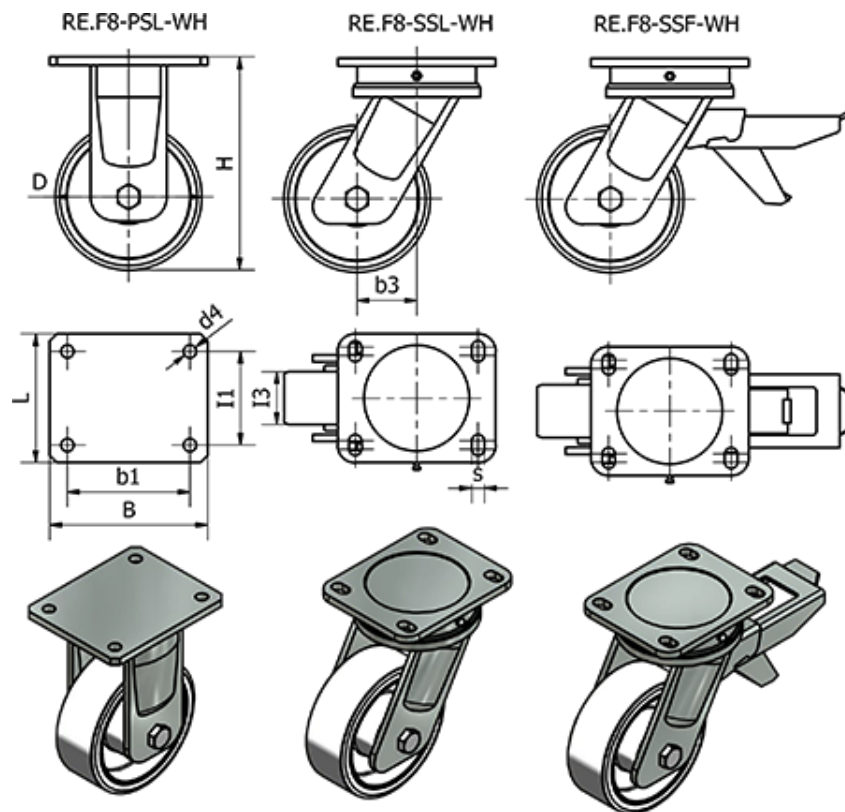

B	= 135	I1	= 80
b1	= 105	I3	= 45
b3	= 51	L	= 110
Code	= 449461	R	= 157
D	= 125	Rolling resistance (N)	= 4000
d4	=	s	= 11
Dynamic carrying capacity (N)	= 6500	Type	= RE.F8-125-SSL-WH
H	= 182	Weight (g)	= 3510